

SONOROUS

SONOROUS®

At Sonorous, we believe your entertainment system should be complimented by specialist AV (Audio Video) furniture that displays your TV, not your wires. It should also be totally functional, giving an accessible yet discrete and bespoke home to your entertainment system. Choose confidently from our contemporary designs that will compliment your personal style and the carefully selected furnishings in your home.

Index	Pages
ELEMENTS MULTIMEDIA CABINETS :	4-17
ELEMENTS SIDEBARDS :	18-37
TABLES :	38-51
SHELF & BOX SYSTEM :	52-57
FEATURES:	58-67
COLOR VARIABLES :	68-71
PRODUCT INFORMATION :	72-106



ELEMENTS MULTIMEDIA CABINETS

ELEMENTS brings Sonorous design, creativity and styling to a new level. A modular concept that displays and discreetly stores all your Audio / Video equipment right at the heart of your living space.

Special attention has been given to provide discrete and practical storage for all your home entertainment, yet meet the style and design requirements of the most carefully furnished home.

Contemporary designs of lacquered tempered glass and wood are at the core of Elements. The concept is simple and convincing. Quality without compromise.















ELEMENTS SIDEBOARDS

Sonorous introduces **ELEMENTS SIDEBOARDS** , a new cabinet system designed by Sonorous

The body come in four different width and five different height with doors, flaps and drawers . By playing with different colors and materials (Glass, wood, ceramic, veneer) and layout you can create your own cabinet.

The different boxes are put next to each other with a continuous delicate glass on top
Sideboard is available in both standing on wood base or a metal frame.

Wall hanging for the single module or the whole combination is also an option.





















TABLES DINING TABLES

Sonorous is proud to introduce new **table** series.

The ceramic and/or glass table-top contrasts beautifully with metal or solid wood leg frame options. **Tables** of different heights can be grouped together as nest sets, with the smaller version used as a coffee or occasional table and the larger piece as a dining table.

Our latest collections are right at home in the most diverse interiors, becoming a timeless part of your own personal design style.”

COFFEE TABLES & SIDE TABLES

Sonorous introduces **Coffee Tables & Side Tables** designed by Sonorous

A series of **Coffee Tables and Side Tables** – with different heights and table top sizes are ideal for your living rooms or any types of interiors. By mixing the colors of the metal bases and table tops, the expression of the tables may be varied infinitely.

Coffee tables/side tables made up of two types.

One type comes with metal legs and top panels are either tempered glass or ceramic.

Second type is constructed with the same idea as Elements cabinets.













SHELF & BOX SYSTEM

Shelf & Box features steel bars that allow multiple storage options, the system range from smallest design to the largest solutions. It also offer configurations with a different materials(wood, tempered glass, ceramics) and wide range of colors according to your taste. The system can be adapted into different purposes(bookshelf, sideboard, organizer, showcase) in homes, offices and all living areas.





FEATURES

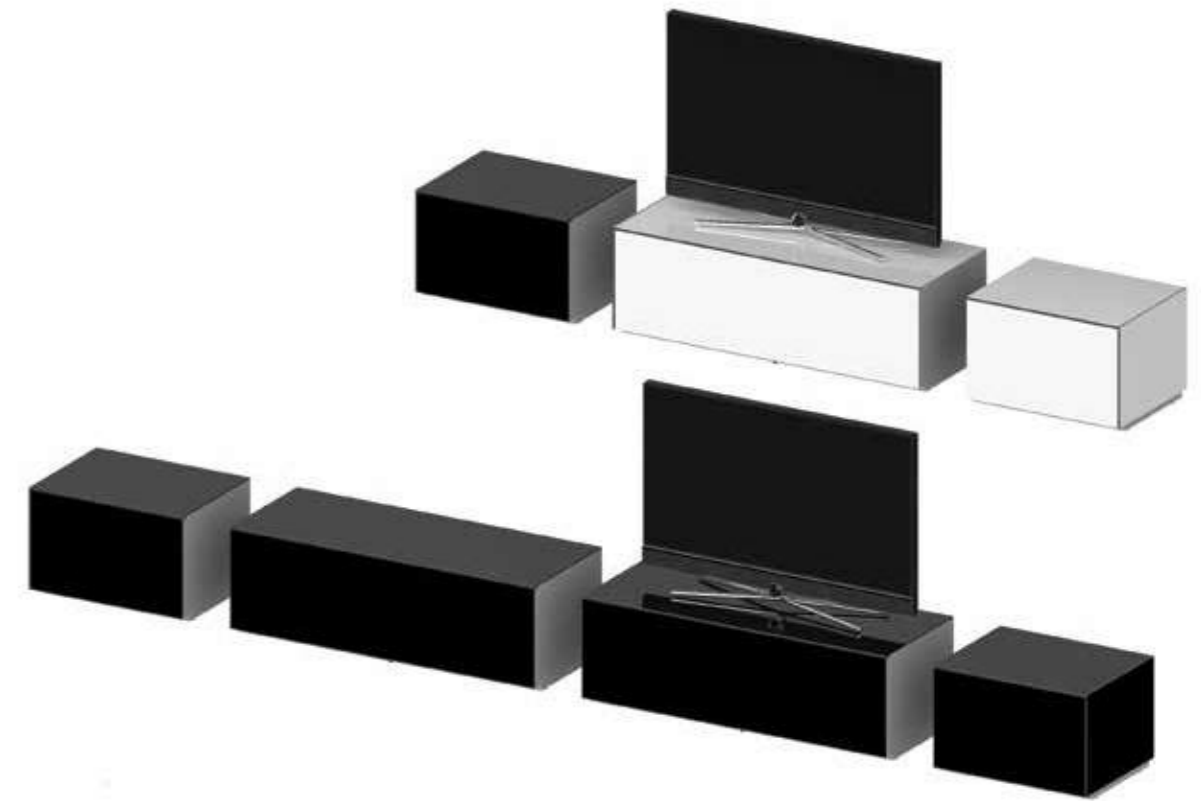

MODULAR CONSTRUCTION (EX / SB)

Modular construction allows you to arrange cabinets as you require, floor standing, attached to your walls, or both, you decide. A system of specialist furniture that combines elegance, technical performance and perfection.

FEATURES

COLOR VARIABLES

PRODUCT INFORMATION

ELEMENTS
SIDEBOARD
TABLES
SHELF & BOX SYSTEM

Pages

58-67

68-71

71-106

71-87

87-97

98-103

104-106

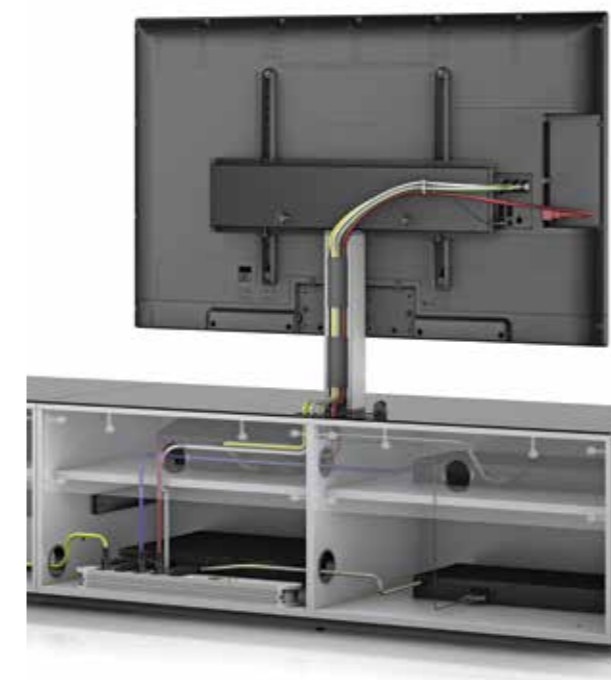

CABLE MANAGEMENT (EX)

Cables are an essential part of your system, but you don't want to see them. Multiple and discrete horizontal and vertical cable channels make for easy access for cabling through shelves and cabinets whilst keeping them out of sight within the cabinet.



ROTATING MOUNT (EX)

Brushed anodised aluminium profile is used for TV mounting and provides rotating and an integrated cable management system.



ACOUSTIC FABRIC DOOR (EX / SB)

Amplifier, media players and game consoles can all be stored behind flaps which are covered with acoustic fabric door or perforated door. Designed to ensure adequate ventilation so your devices don't overheat. A sound bar, loudspeakers and subwoofers can be placed and operated, hidden from view, without affecting performance.



PERFORATED DOOR (EX / SB)



ANODISED ALUMINIUM EDGES (EX)

Careful use of anodized aluminium profiles creates impact resistance edges



CERAMIC TABLE

Ceramic laminated with glass, promises a long-term use in your interiors.



CERAMIC DOOR (EX / SB)



VENEER DOOR (EX / SB)



IR REPEATER (EX)

Control all your equipment with your remotes, yet keeping it out of sight. Our Infrared Repeater system relays remote control signals to your equipment within the cabinet



PUSH TO OPEN (EX / SB)



FLAP DOOR MECHANISM (EX / SB)
High-quality flap mechanisms ensures soft opening and closing.



DRAWER (EX / SB)
Drawers incorporate high performance and luxury "push to open" mechanisms



ADJUSTABLE LEVELLING FEET FOR METAL LEGS (EX / SB)



ADJUSTABLE LEVELLING FEET FOR BASES (EX / SB)

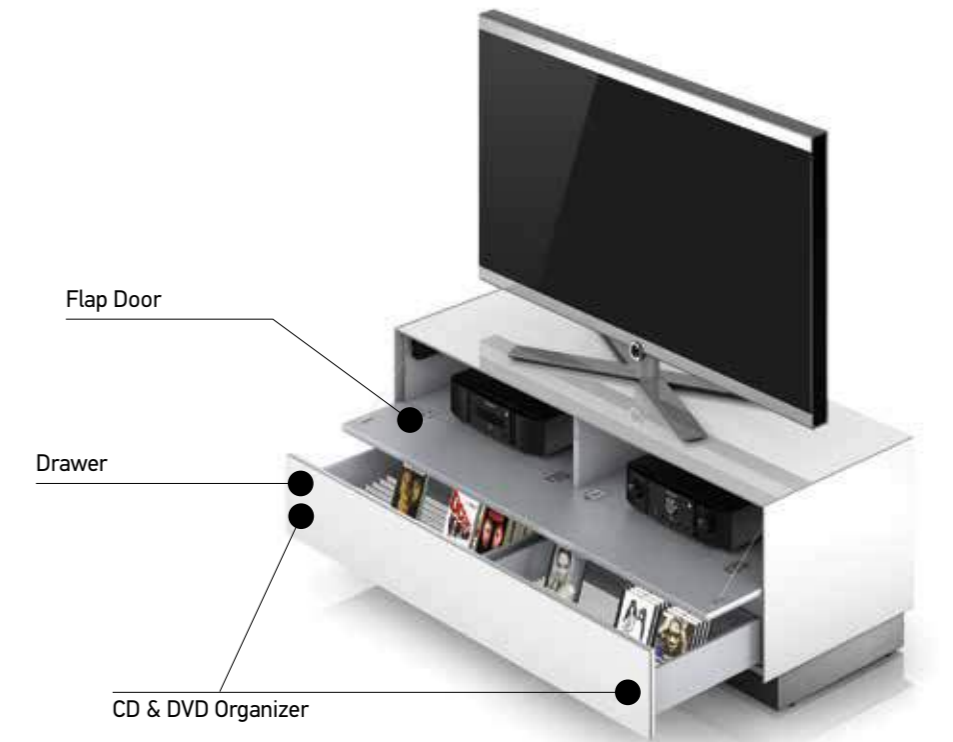

Flap Door

Drawer

CD & DVD Organizer

DRAWER SLIDES & FLAP DOORS

Anodized aluminium CD and DVD storage can be integrated into drawers.

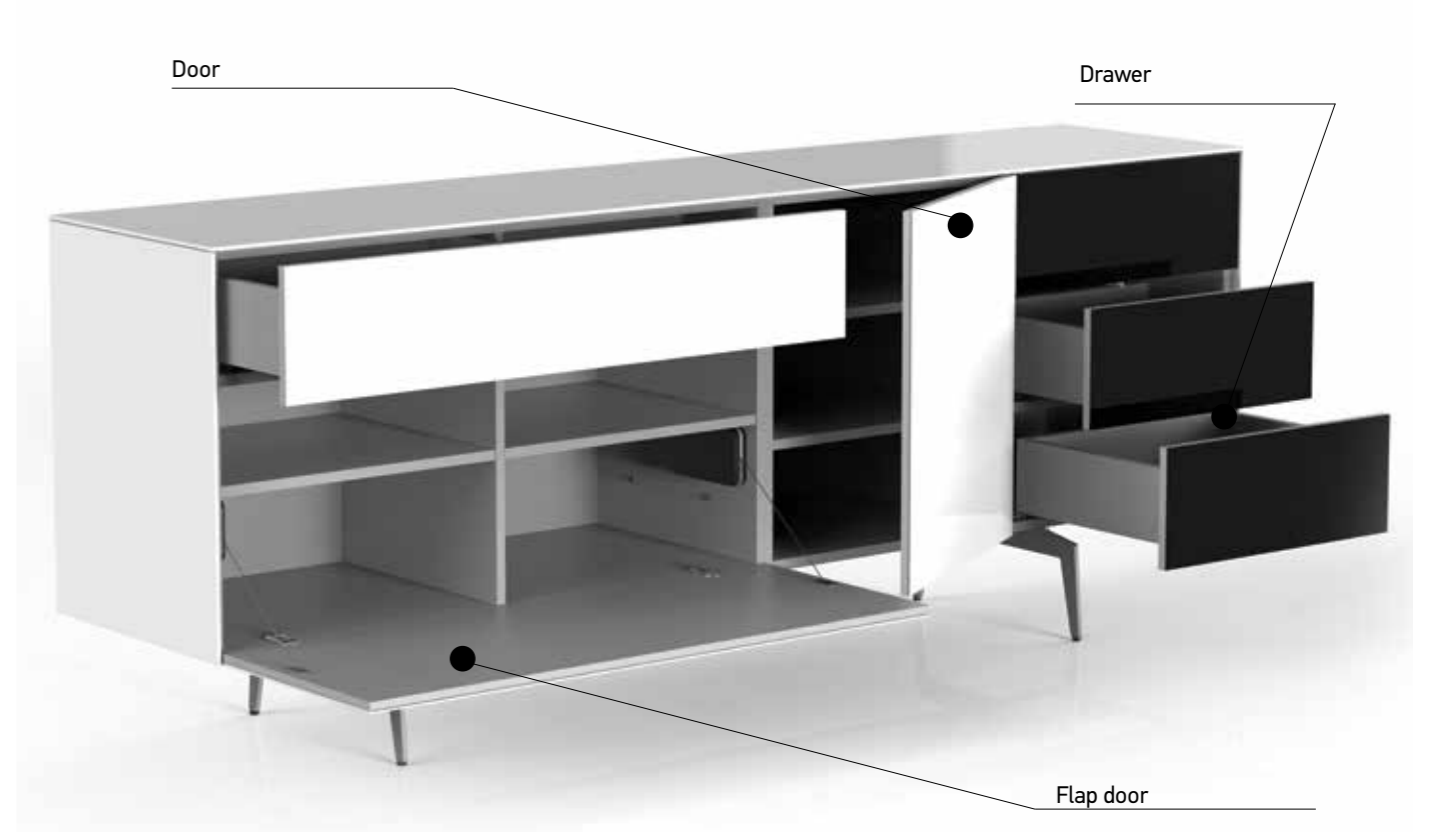

Door

Drawer

Flap door

DRAWER SLIDES
FLAP DOORS & SIDE OPENING DOORS

CHOICE OF BASES



1. CRAB 13 cm



2. PLAIN 13 cm



5. CAGE 40 cm



6. CAGE 20 cm



3. BASE 3,5 cm



4. BASE 9 cm



7. SPIKE 20 cm / 13 cm



8. TUBE 13 cm

CHOICE OF TABLE LEGS



1. CHEVRON 74 cm



6. TWIN 74 cm



7. MIRROR 74 cm



2. TRAPEZOID 74 cm



3. WARP 74 cm



8. GONDOLA 74 cm



9. CONE 74 cm



4. MAZE 74 cm



5. PORTAL 74 cm



10. NET 74 cm

COLOR VARIABLES

Finishes to match different tastes and needs. Tempered glass colors and wood finishes, allow you to choose and compliment your style.

GLASS COLORS

CATEGORY : Shiny (A) Matte (A+)



WOOD DECORS

CATEGORY (B)



OPEN CABINET WOOD DECORS

CATEGORY (B+)

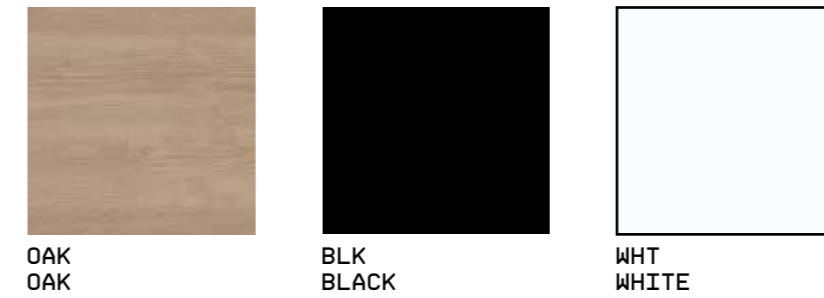

VENEER DECORS

CATEGORY (C)

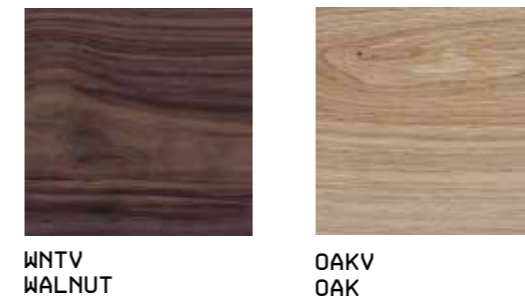

FABRIC COLORS

CATEGORY (E)



METAL COLORS (FOR PERFORED DOORS AND METAL LEGS)

CATEGORY (D)



CERAMIC COLORS (Matte)

CATEGORY (F)



CERAMIC COLORS (Shiny)

CATEGORY (F+)

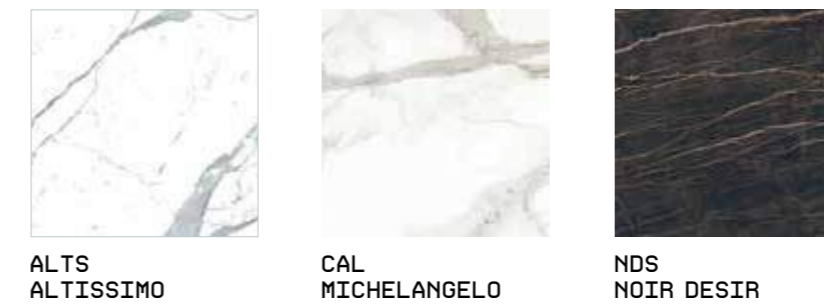

FLOOR CABINETS

160 x 40 CM (WITH HOLE)

EX30F
(Adjustable shelf + 4 cm)

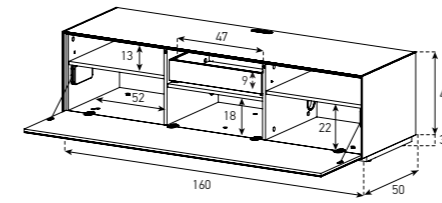

EX30TS / PS

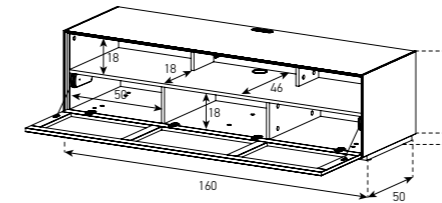

EX30-PF

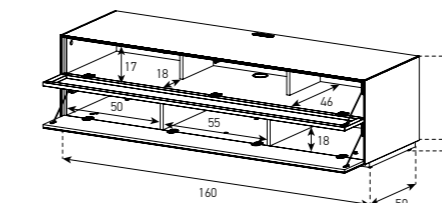

160 x 40 CM (WITH HOLE & BRACKET)

EX31F
(Adjustable shelf + 4 cm)

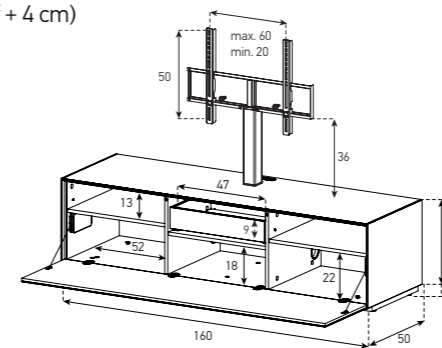

EX31TS / PS

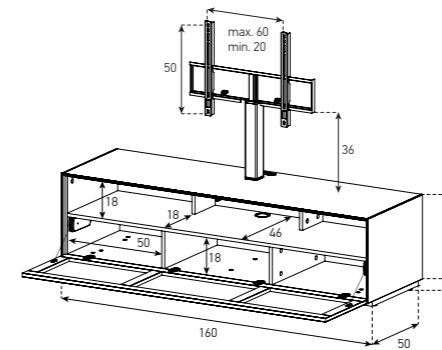

EX30TC / PC
(Adjustable shelf + 4 cm)

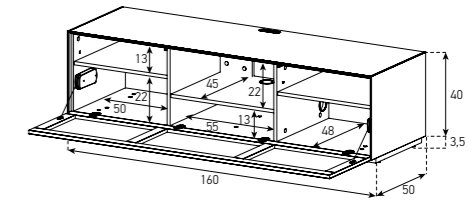

EX30FF

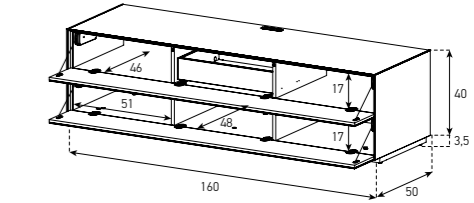

EX31TC / PC
(Adjustable shelf + 4 cm)

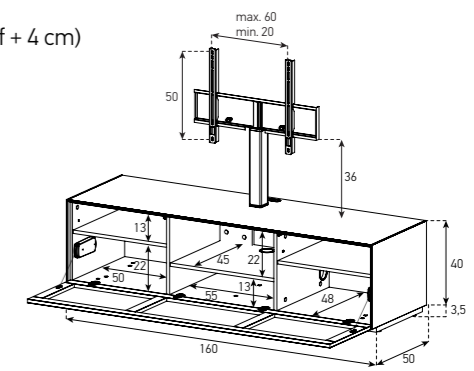

EX31FF

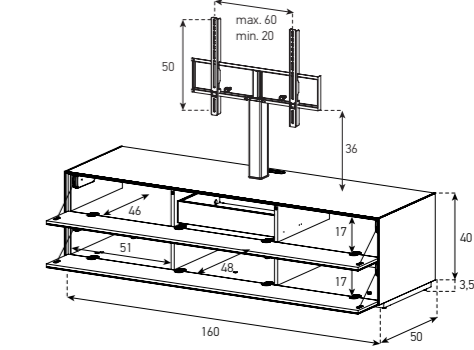

EX31PF

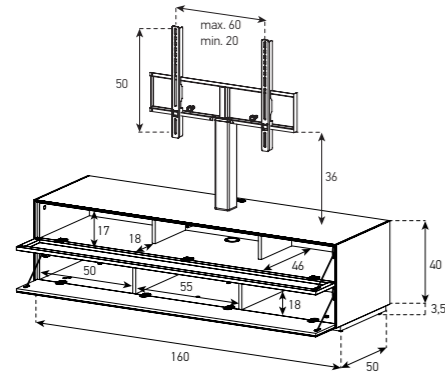

160 x 40 CM (WITHOUT HOLE)
EX32F
(Adjustable shelf + 4 cm)

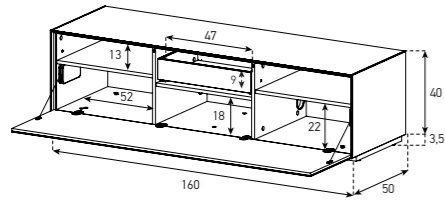

EX32TS / PS

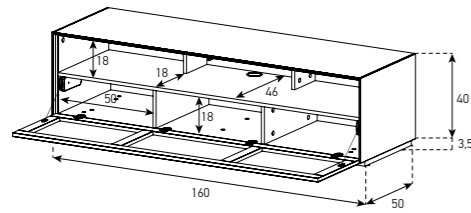

EX32PF

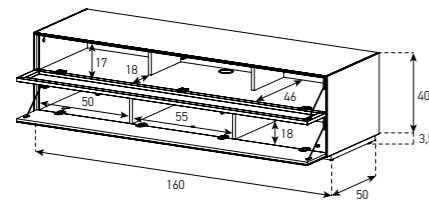

EX32TC / PC
(Adjustable shelf + 4 cm)

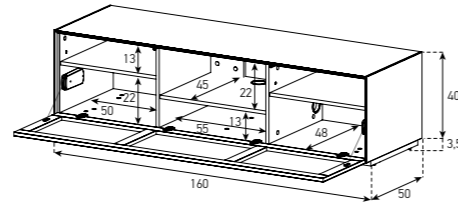

EX32FF

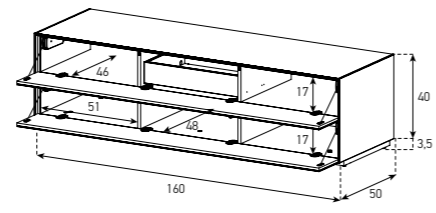

130 x 40 CM (WITH HOLE)
EX10DD

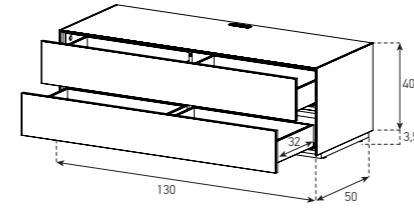

EX10FD

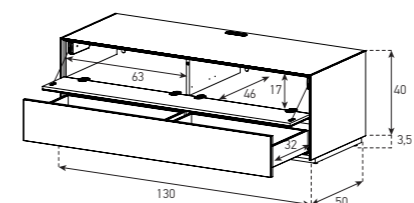

EX10TC / PC

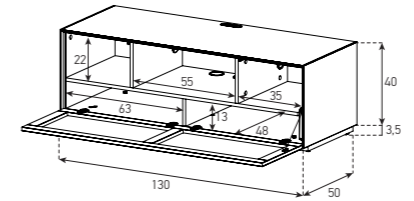

EX10TF / PF

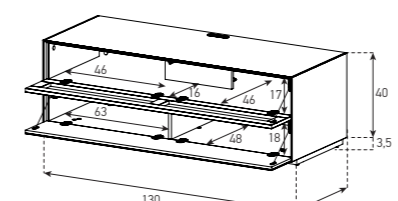

EX10TT / PP

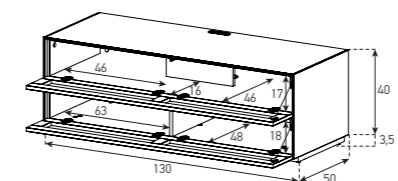

EX10F
(Adjustable shelf + 4 cm)

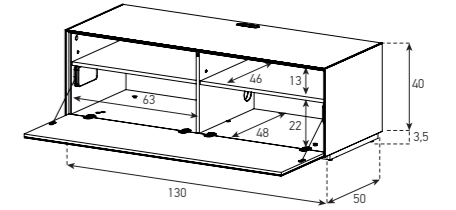

EX10FF

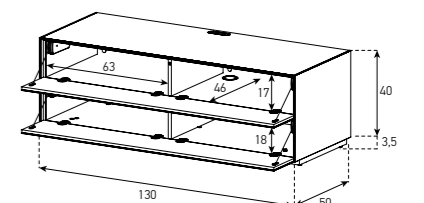

EX10TD / PD

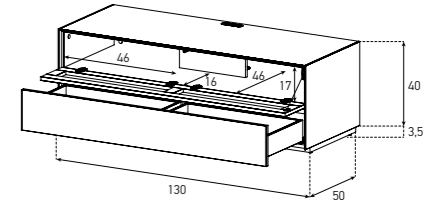

EX10TS / PS

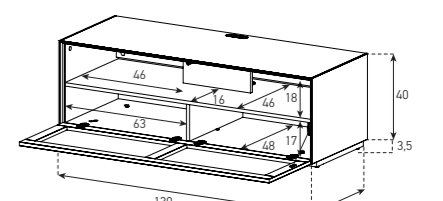

130 x 40 CM (WITH HOLE & BRACKET)

EX11DD

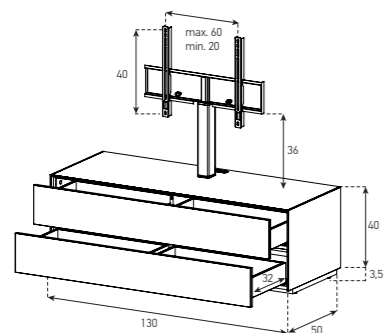

EX11F
(Adjustable shelf + 4 cm)

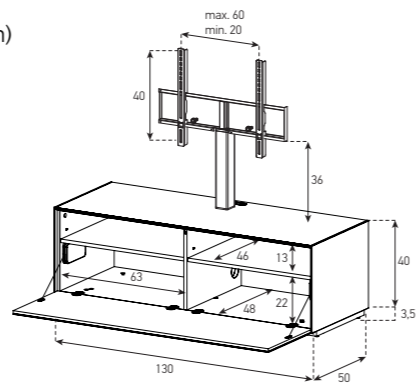

130 x 40 CM (WITHOUT HOLE)
EX12DD

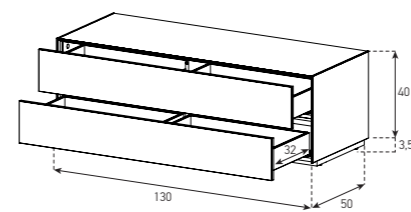

EX12F
(Adjustable shelf + 4 cm)

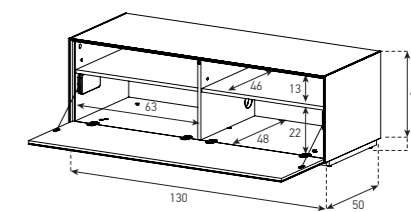

EX11FD

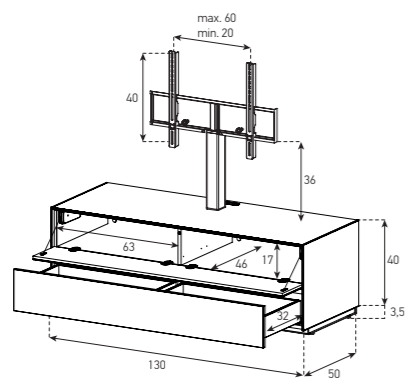

EX11FF

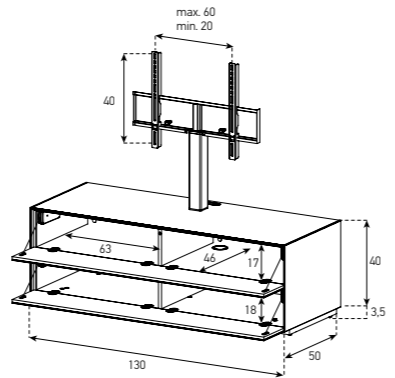

EX12FD

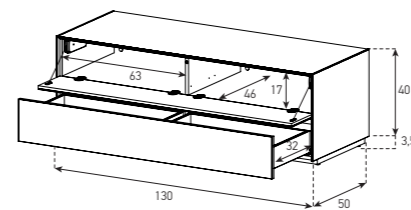

EX12FF

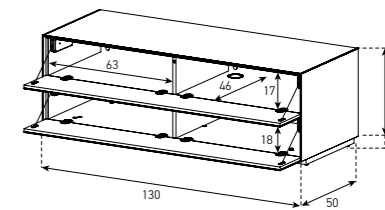

EX11TD / PD

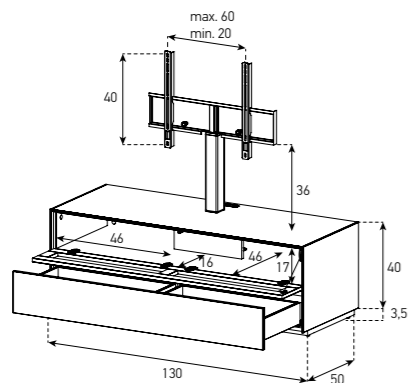

EX11TF / PF

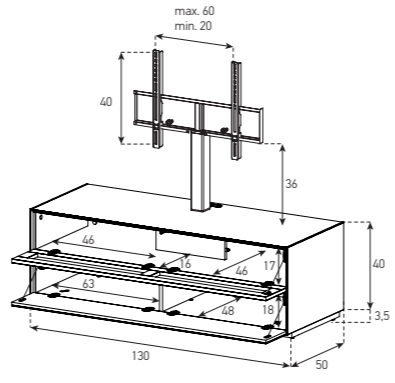

EX12TC / PC

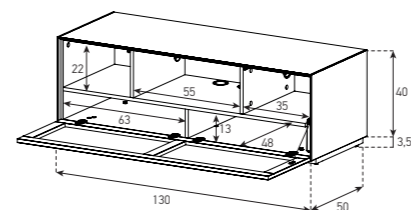

EX12TD / PD

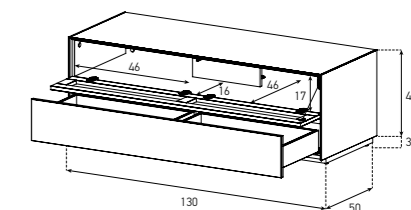

EX11TS / PS

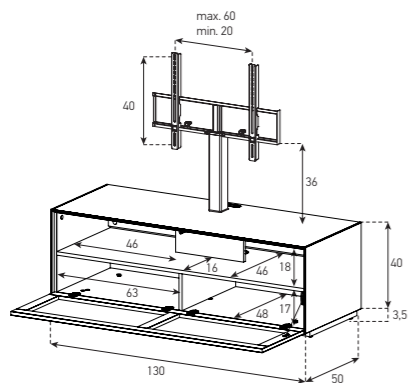

EX11TT / PP

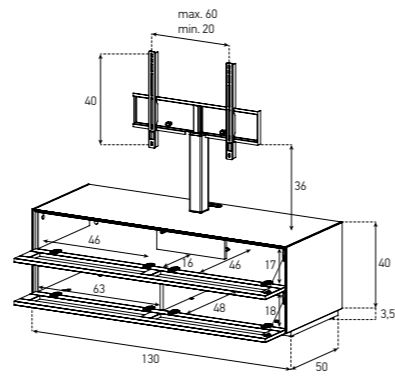

EX12TF / PF

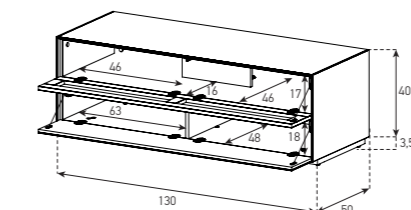

EX12TS / PS

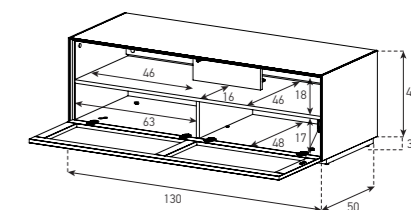

EX12TT / PP

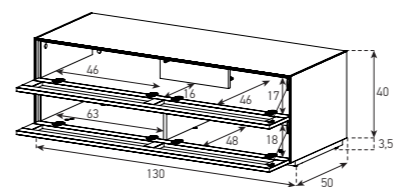

160 x 25 CM (WITH HOLE)
EX35F

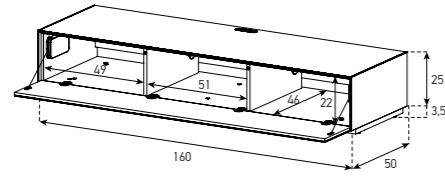

EX35TS / PS

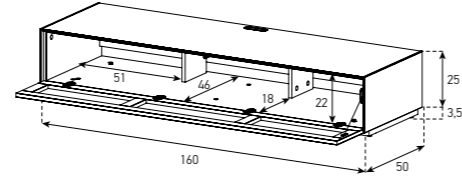

130 x 25 CM (WITH HOLE & BRACKET)
EX16D

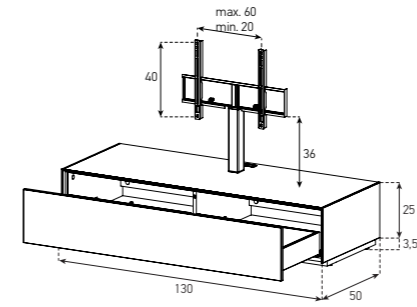

EX16F

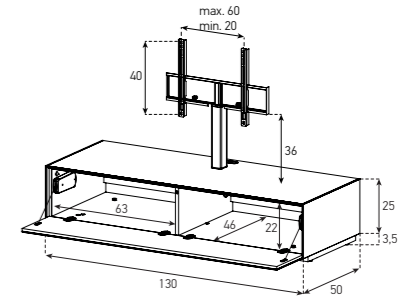

160 x 25 CM (WITH HOLE & BRACKET)
EX36F

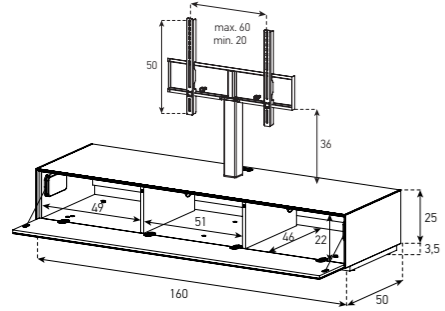

EX36TS / PS

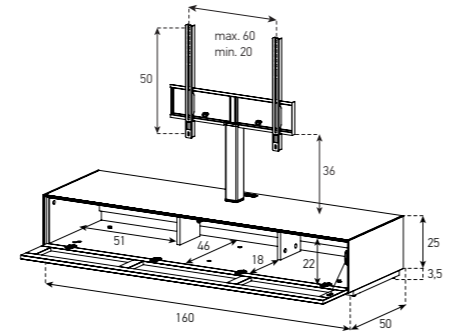

EX16TS / PS

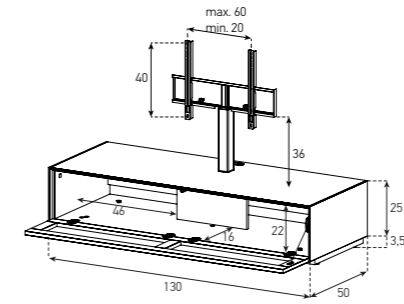

160 x 25 CM (WITHOUT HOLE)
EX37F

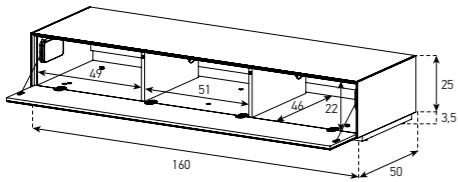

EX37TS / PS

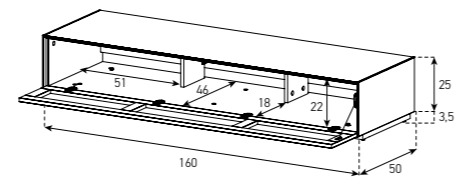

130 x 25 CM (WITHOUT HOLE)
EX17D

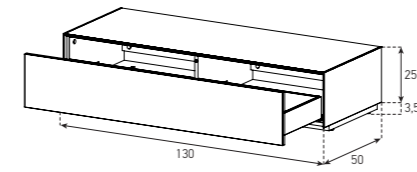

FLOOR CABINETS 130 x 25 CM (WITH HOLE)
EX15D

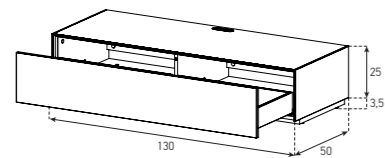

EX15F

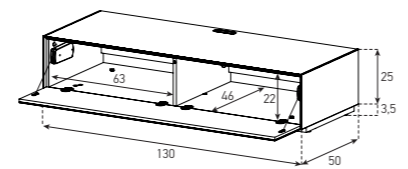

EX17F

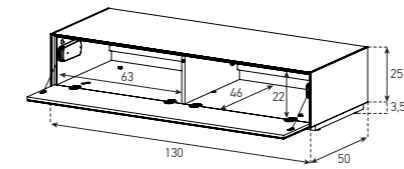

EX17TS / PS

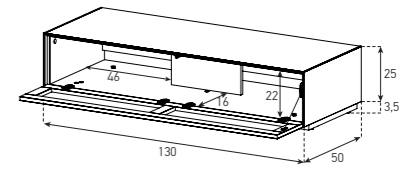

EX15TS / PS

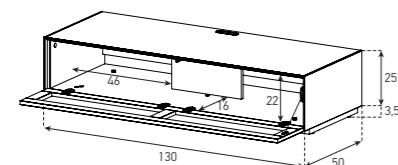

65 x 40 CM
EX20D
(Adjustable shelf + 4 cm)

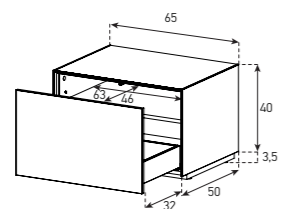

EX20DD

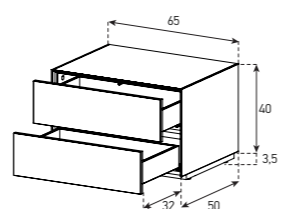

EX20F
(Adjustable shelf + 4 cm)

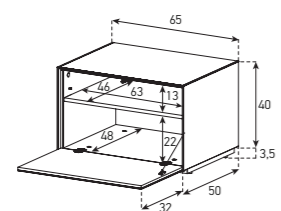

EX20FD

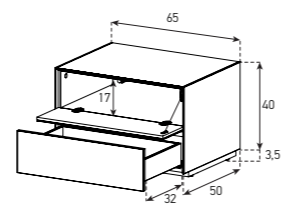

EX20FF

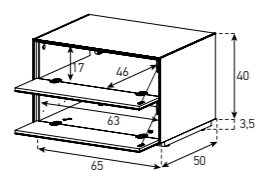

EX20TS / PS
(Adjustable shelf + 4 cm)

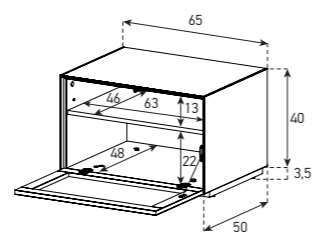

WALL UNITS
160 x 40 CM
ED30F

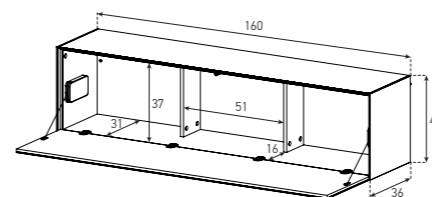

ED30U

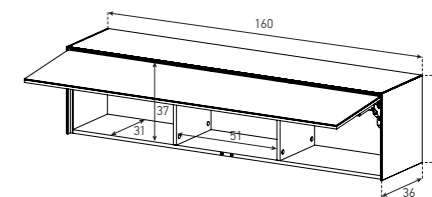

ED30TS / PS

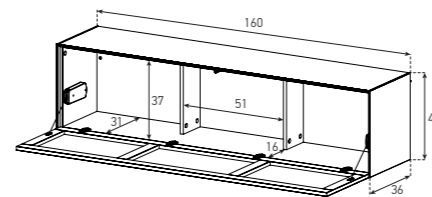

ED31F (WITH CABLE MANAGEMENT)

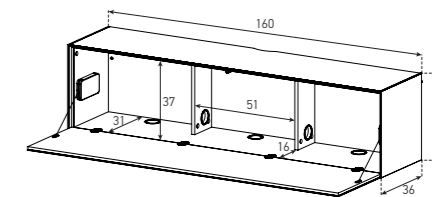

ED31TS / PS(WI)

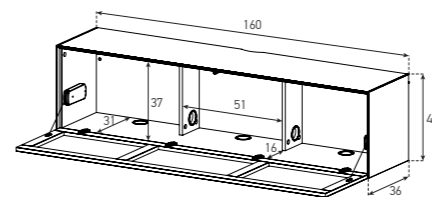

FOR TURN TABLE
ER01F

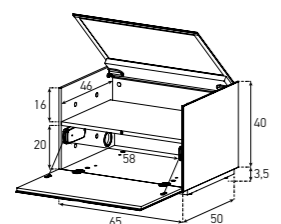

FOR MOBILE DEVICE
EM01F

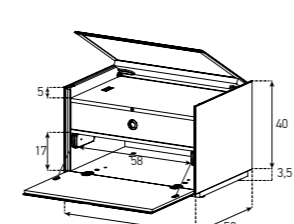

160 x 25 CM
ED35F

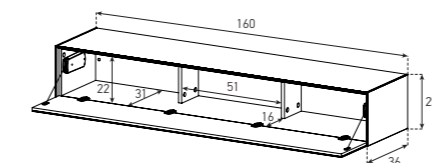

ED35TS / PS

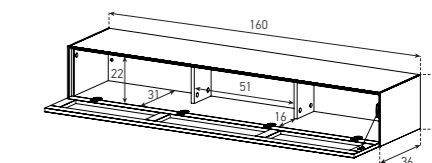

FLOOR CABINETS 65 x 25 CM
EX25D

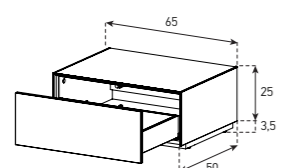

EX25F

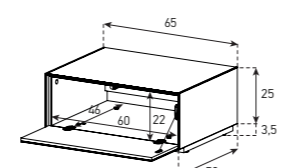

ED36F (WITH CABLE MANAGEMENT)

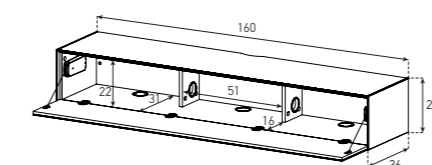

ED36TS / PS (WITH CABLE MANAGEMENT)

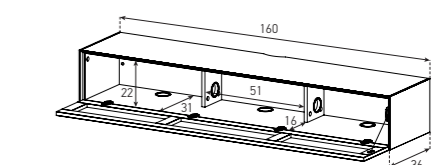

130 x 40 CM
ED60F

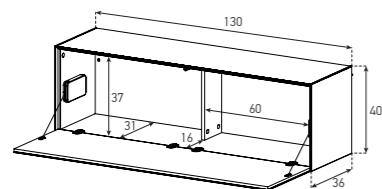

ED60U

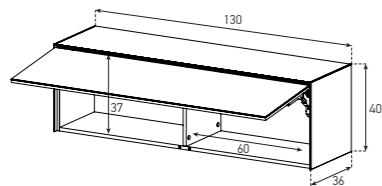

ED60TS / PS

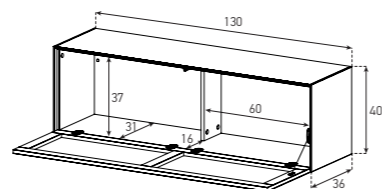

ED61F (WITH CABLE MANAGEMENT)

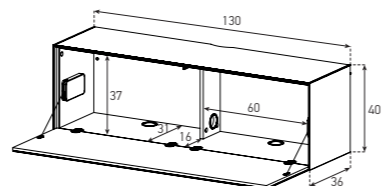

ED61TS / PS (WITH CABLE MANAGEMENT)

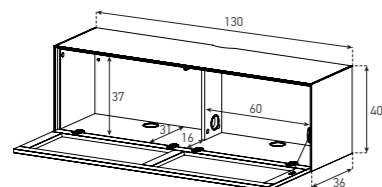

130 x 25 CM
ED65F

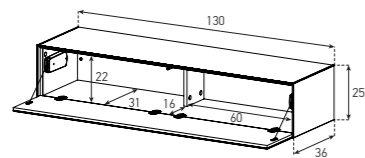

ED65TS / PS

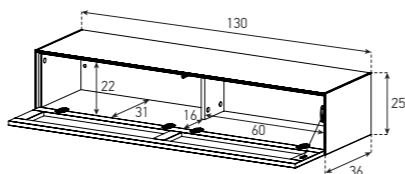

ED66F (WITH CABLE MANAGEMENT)

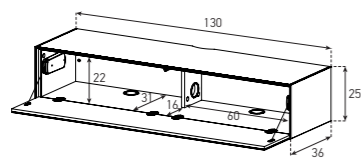

ED66TS / PS (WITH CABLE MANAGEMENT)

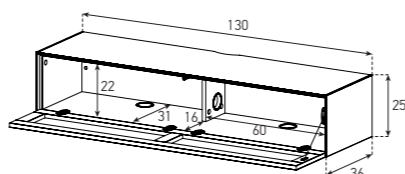

40 x 100 CM
ED70DR / DL
(Adjustable shelf +/- 6 cm)

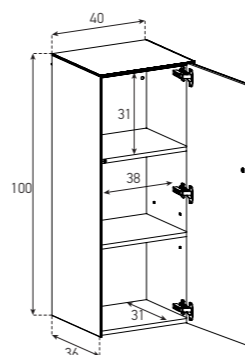

25 x 100 CM
ED75DR / DL
(Adjustable shelf +/- 6 cm)

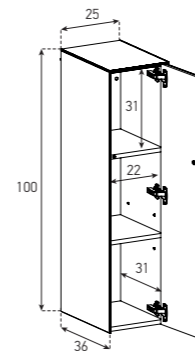

40 x 100 CM
ED71DR / DL
(Removable shelf)

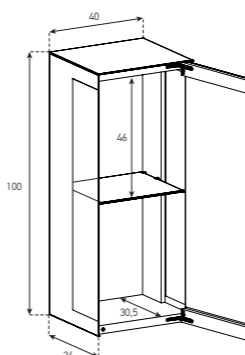

40 x 130 CM
ED80DR / DL
(Adjustable shelf +/- 6 cm)

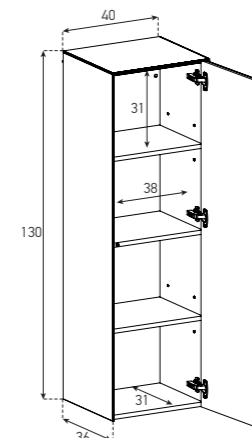

25 x 130 CM
ED85DR / DL
(Adjustable shelf +/- 6 cm)

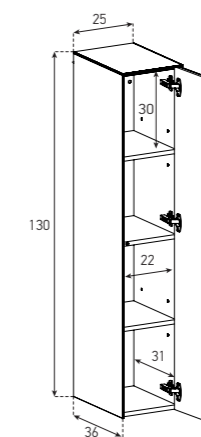

40 x 130 CM
ED81DR / DL
(Removable shelf)

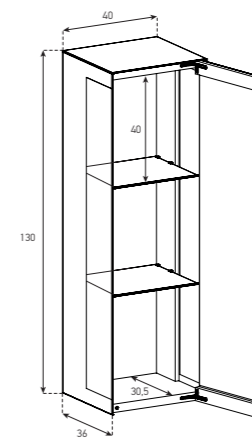

40 x 160 CM
ED90DR / DL
(Adjustable shelf +/- 6 cm)

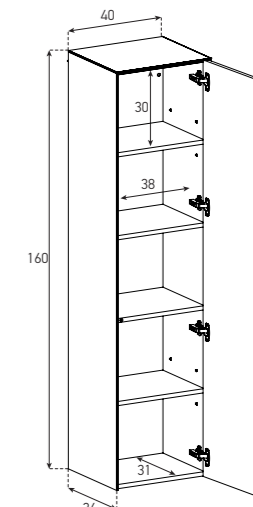

25 x 160 CM
ED95DR / DL
(Adjustable shelf +/- 6 cm)

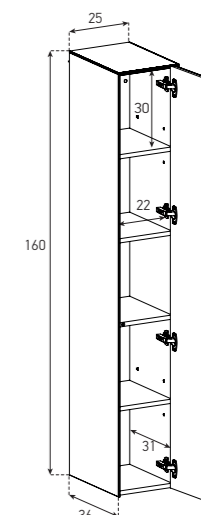

40 x 160 CM
ED91DR / DL
(Removable shelf)

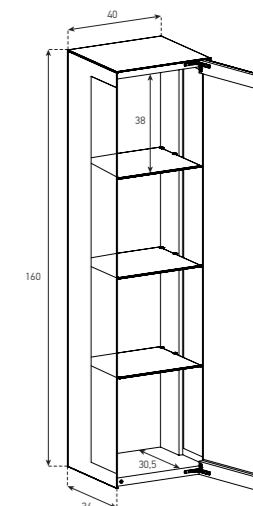

25 x 100 CM
ED76DR / DL
(Removable shelf)

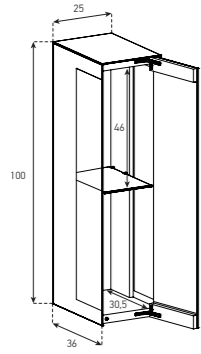

25 x 130 CM
ED86DR / DL
(Removable shelf)

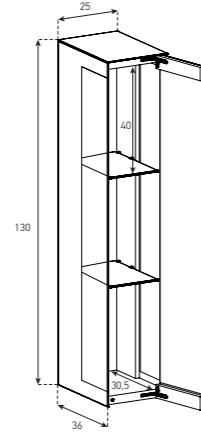

25 x 160 CM
ED96DR / DL
(Removable shelf)

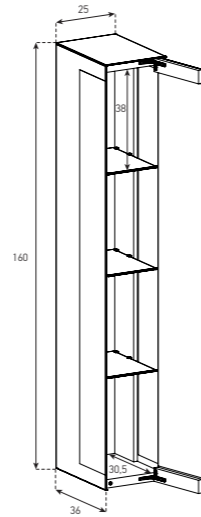

65 x 40 CM
ED 50F

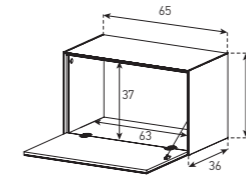

ED50U

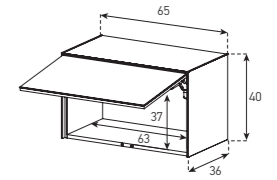

65 x 25 CM
ED 55-F

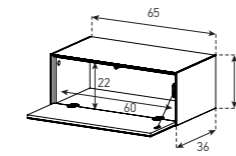

WALL UNITS (Open cabinets can be hang either vertical or horizontal.)

40 x 100 CM
OP70V (vertical)
OP70H (horizontal)

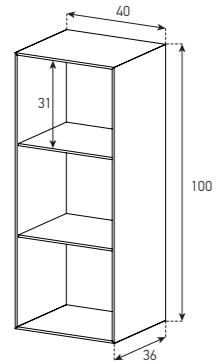

40 x 130 CM
OP80V (vertical)
OP80H (horizontal)

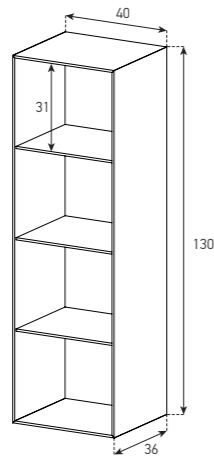

40 x 160 CM
OP90V (vertical)
OP90H (horizontal)

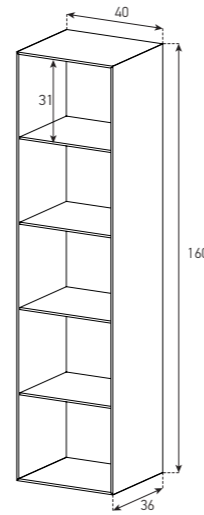

65 X 40 CM
OP50V (vertical)
OP50H (horizontal)

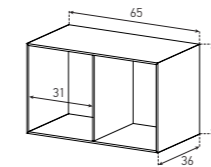

40 X 40 CM
OP40

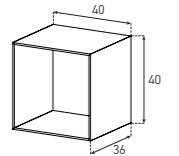

65 X 25 CM
OP55V (vertical)
OP55H (horizontal)

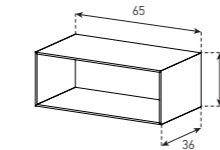

25 X 40 CM
OP45V (vertical)
OP45H (horizontal)

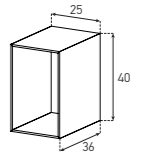

25 x 100 CM
OP75V (vertical)
OP75H (horizontal)

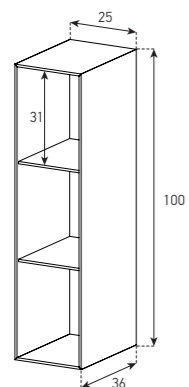

25 x 130 CM
OP85V (vertical)
OP85H (horizontal)

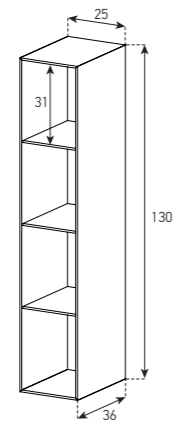

25 x 160 CM
OP95V (vertical)
OP95H (horizontal)

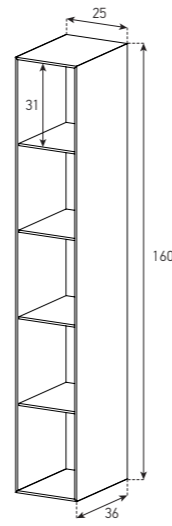

ACCESSORIES
AL-HECD
CD Organizer

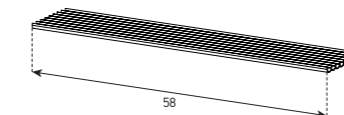

AL-HEDVD
DVD Organizer

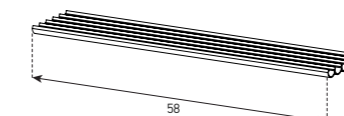

IR 3000
Infrared Repeater

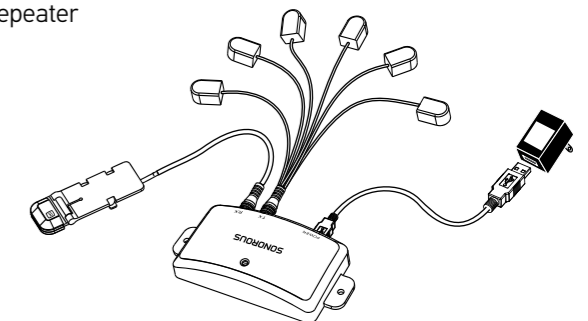

**ELEMENTS CODE SAMPLE
(Floor Cabinets)**

EX10FF-WHT-WHT-CG2BLKA

1 2 3 4 5 6 7

1) Cabinet Types

EX30 (With Hole)
EX31 (With Hole & Bracket)
EX32 (Without Hole)

EX10 (With Hole)
EX11 (With Hole & Bracket)
EX12 (Without Hole)

EX20

ER01
EM01

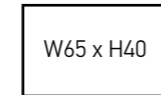
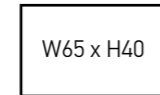
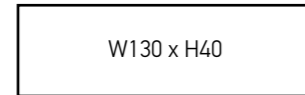
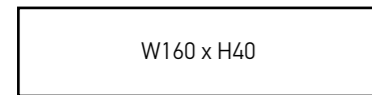

EX35 (With Hole)
EX36 (With Hole & Bracket)
EX37 (Without Hole)

EX15 (With Hole)
EX16 (With Hole & Bracket)
EX17 (Without Hole)

EX25

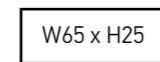
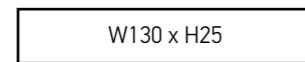
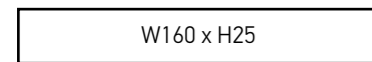

2) Cabinet Doors :

F
(Flap Down)

D
(Drawer)

FF
(Flap Down&Flap Down)

FD
(Flap Down & Drawer)

DD
(Drawer & Drawer)

TS
(Textile - Soundbar compatible body)

TC
(Textile - Center speaker compatible body)

TT
(Textile & Textile)

TF
(Textile & Flap down)

TD
(Textile & Drawer)

PS
(Perforated - Soundbar compatible body)

PC
(Perforated - Center speaker compatible body)

PP
(Perforated & Perforated)

PF
(Perforated & Flap down)

PD
(Perforated & Drawer)

3) Cabinet Colors & Decors : Page 68-71 "Category (A, A+, B & F) " (F can produce only without hole)

4) Door Colors & Decors : Page 68-71 "Category (A, A+, B, C, D, E & F) "

5) Base Options : Page 64-65

2 (3,5cm Base)	CG2 (Max.160cm) (20cm Metal Cage)	CRB (13cm Metal Crab)	SPK (130 & 160cm) (20cm Metal Spike)	SPK (130 & 160cm) (13cm Metal Spike)
-------------------	--------------------------------------	--------------------------	---	---

8 (9cm Base)	CG4 (Max.130cm) (40cm Metal Cage)	TBE (130 & 160cm) (13cm Metal Tube)	PLN (130 & 160cm) (13cm Metal Plain)
-----------------	--------------------------------------	--	---

6) Base Colors : Page 68-71 (Base 2 and 8 available only in silver) "Category (D) "

7) Structure Options :



**ELEMENTS CODE SAMPLE
(Wall Cabinets)**

ED50F-WHT-WHT-A

1 2 3 4 5

1) Cabinet Types

ED30
ED31 (With Cms*)

ED60
ED61 (With Cms*)

ED50
OP50

OP40

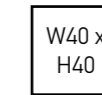
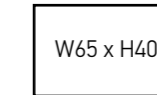
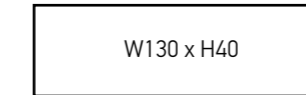
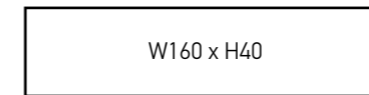

ED35
ED36 (With Cms*)

ED65
ED66 (With Cms*)

ED55
OP55

OP45

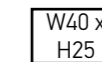
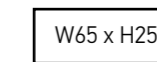
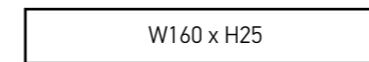

ED90
ED91
OP90

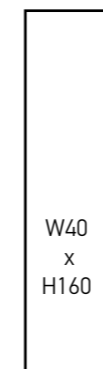

ED80
ED81
OP80

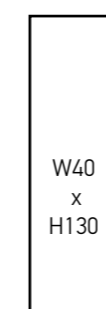

ED70
ED71
OP70

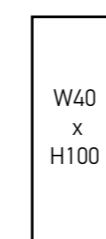

ED95
ED96
OP95



ED85
ED86
OP85

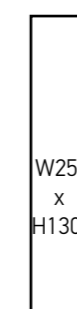

ED75
ED76
OP75

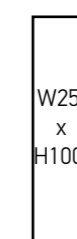

*CMS : Cable Management System

2) Cabinet Doors :

OP Type cabinets doesn't have door.

F
(Flap Down)

U
(Flap Up)

DR
(Door - Right Opening)

DL
(Door - Left Opening)

TS
(Textile - Soundbar compatible body)

PS
(Perforated - Soundbar compatible body)

3) Cabinet Color & Decors : Page 68-71 "Category (A, A+, B, (Just B+ FOR OP) & F) " (F can produce only without hole)

4) Door Colors & Decors : Page 68-71 "Category (A, A+, B, C, D, E & F) "

5) Structure Options :

Vertical wall units & Open cabinet wall units doesn't have structure option



SIDEBOARDS CABINETS
CABINET WITH DRAWER
5043

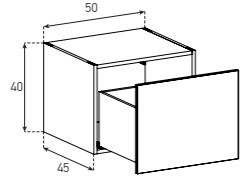

5044

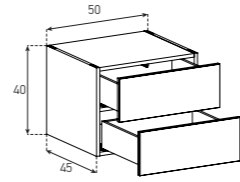

6562

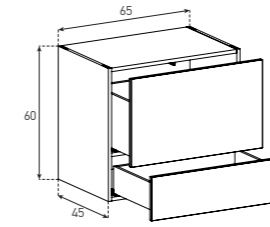

6563

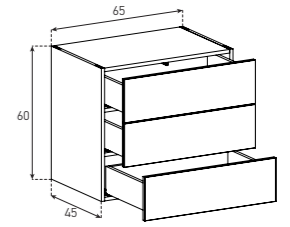

6543

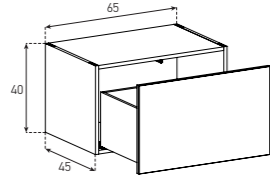

6544

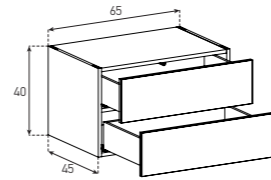

10061

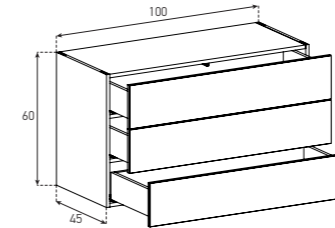

13061

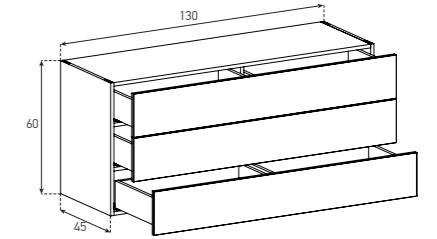

10043

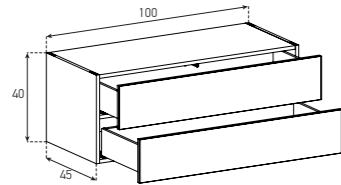

13043

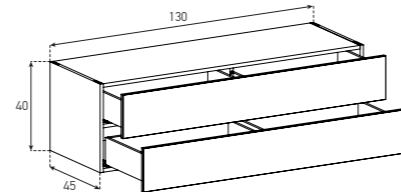

5082

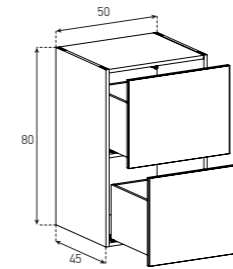

5083

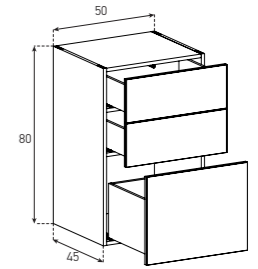

5061

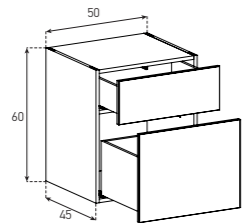

5062

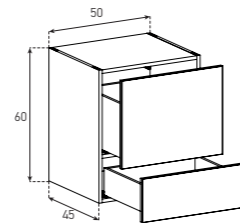

5084

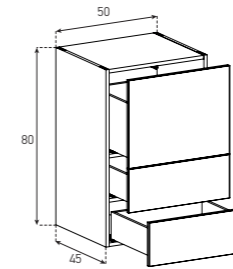

5085

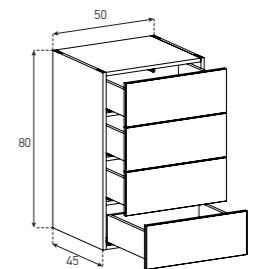

5063

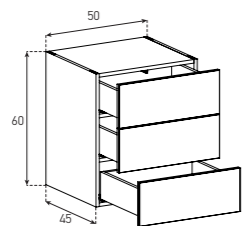

6561

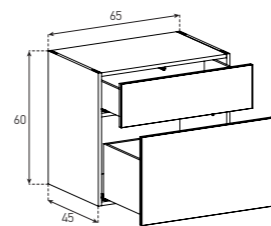

6582

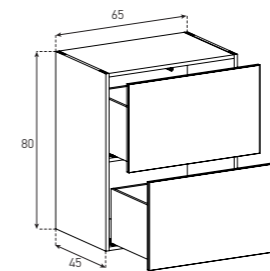

6583

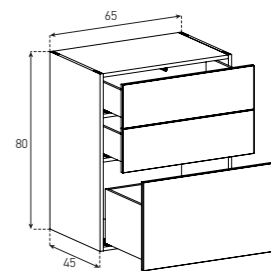

6584

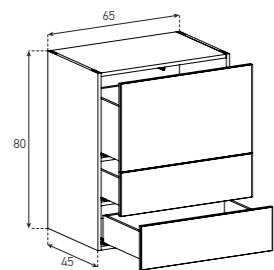

6585

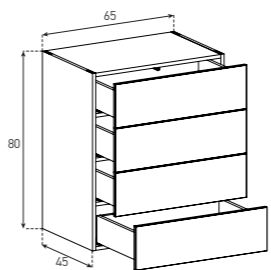

5064 R&L

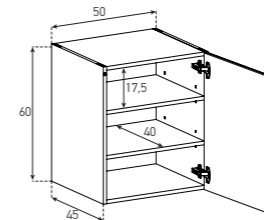

6566 R&L

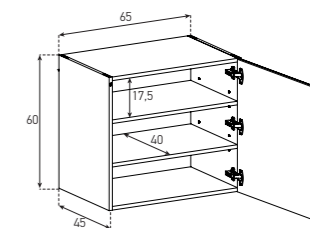

10082

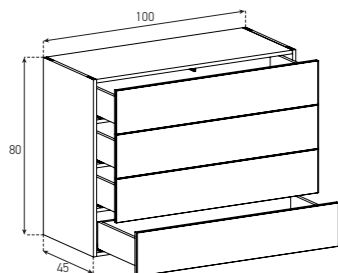

13082

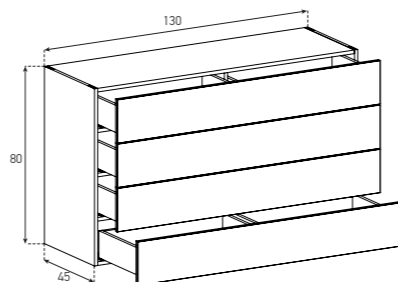

10062

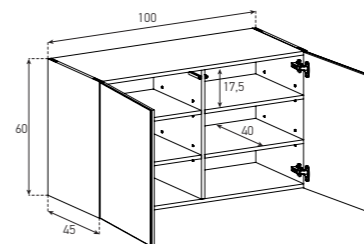

5086 R&L

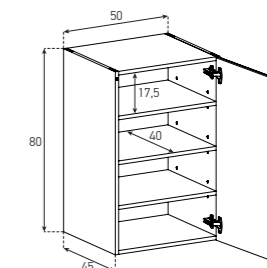

50101

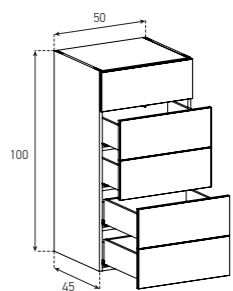

65101

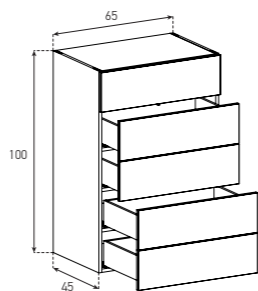

10083

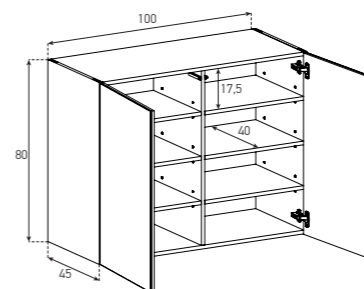

100101

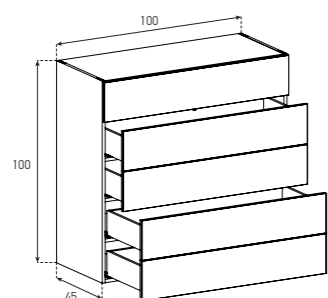

130101

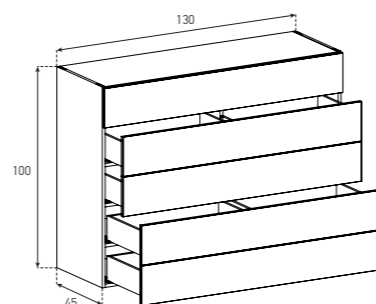

5164 R&L



10162

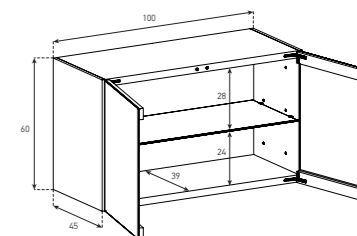
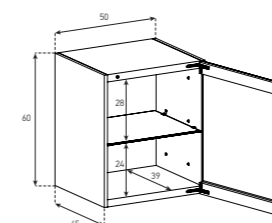

CABINET WITH DOOR
5045 R&L

10044

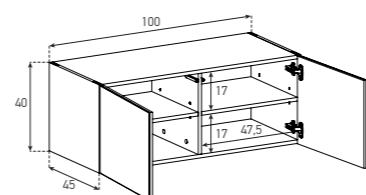
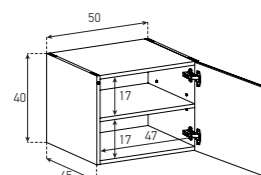

5186 R&L



10183

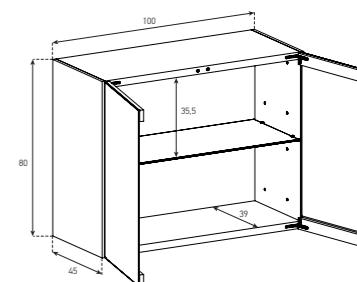
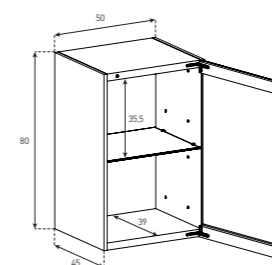

CABINET WITH FLAP DOWN
5041

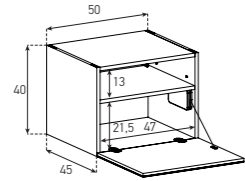

6541

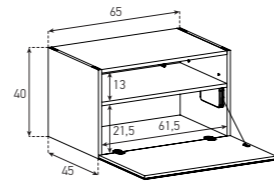

10081

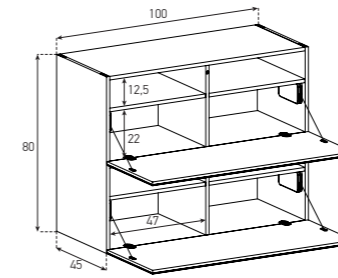

13081

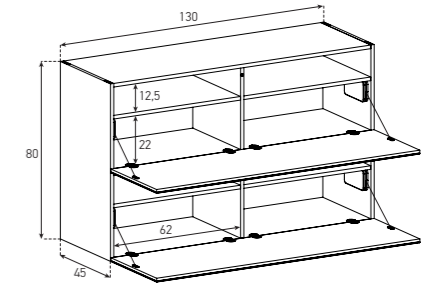

10041

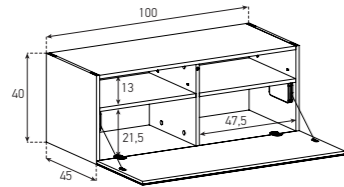

13041

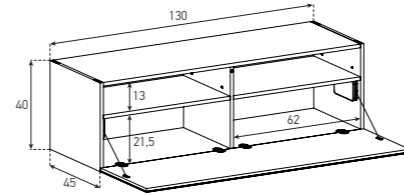

COMBO CABINETS
5046

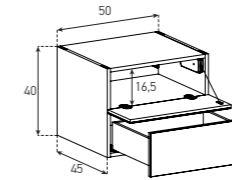

6545

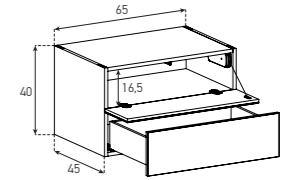

5042

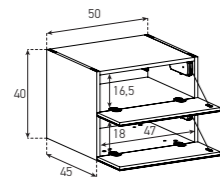

6542

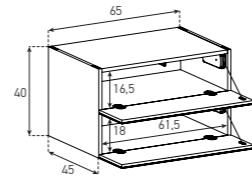

10045

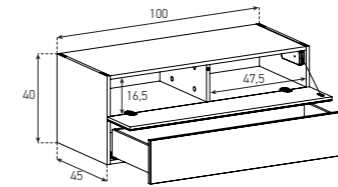

13044

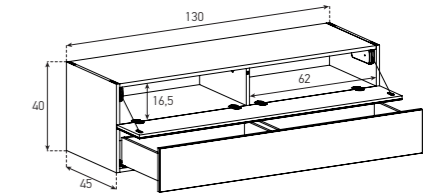

10042

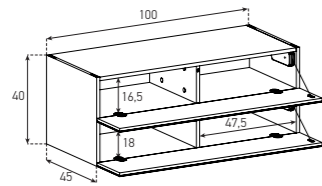

13042

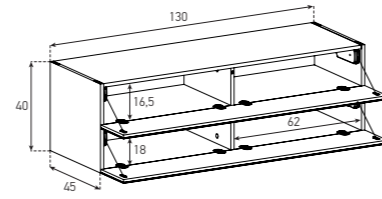

13044 T/P

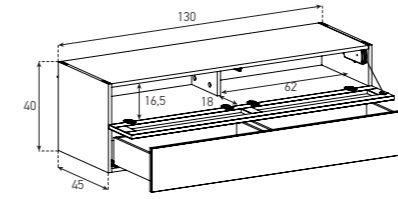

5065

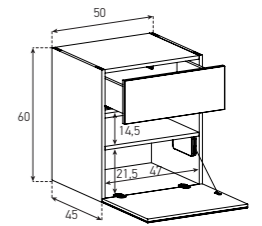

5081

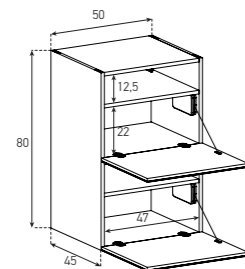

6581

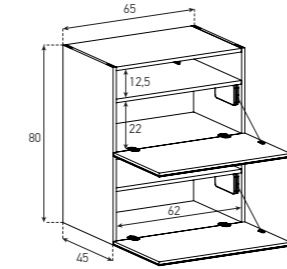

5066

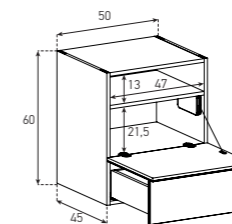

6564

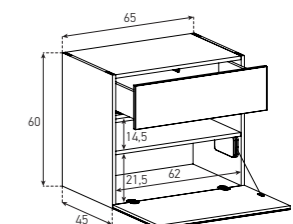

6565

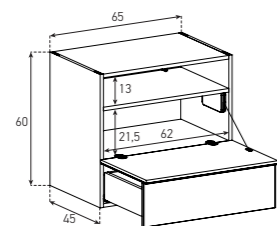

6567

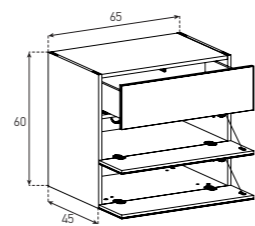

5088

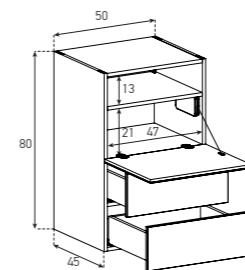

5089

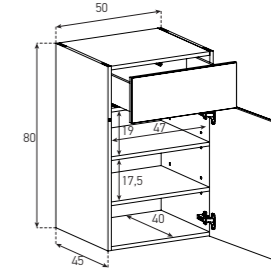

10063

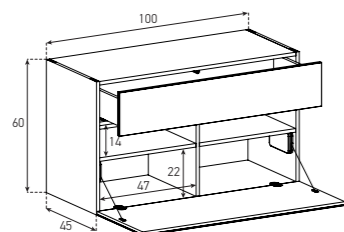

10064

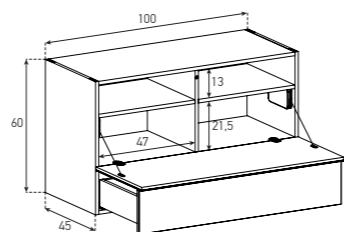

6586

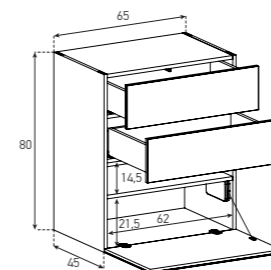

6587

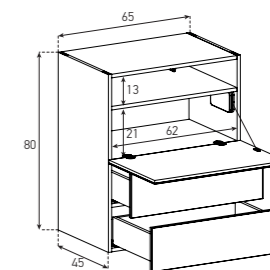

10064 T/P

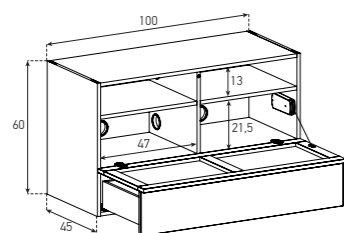

13062

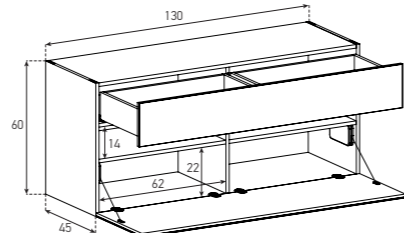

10084

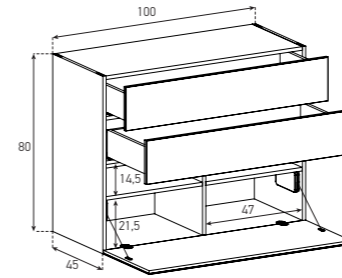

10085

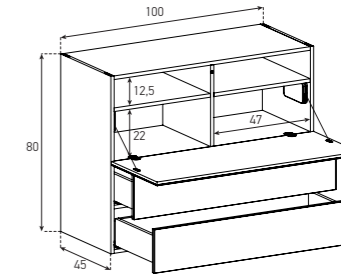

13063

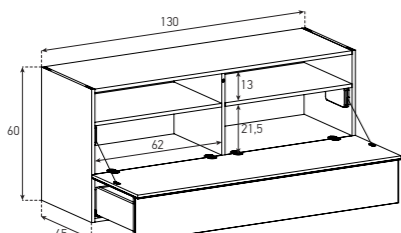

13063 T/P

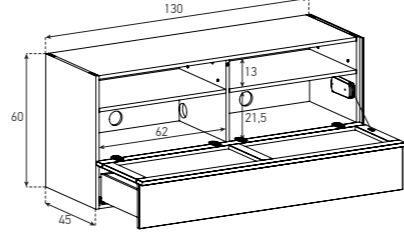

10085 T/P

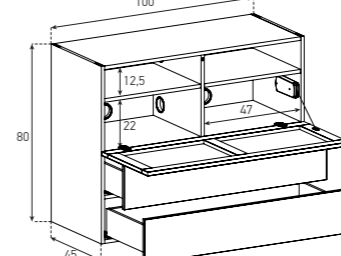

10086

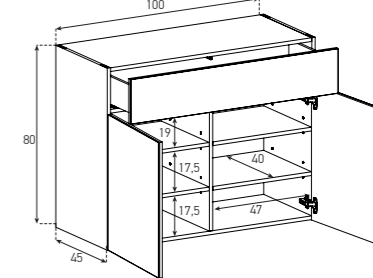

13064 T/P

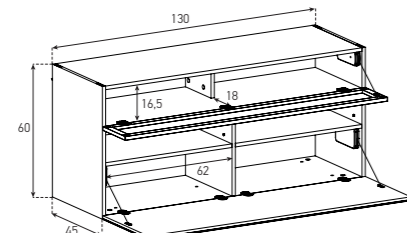

5087

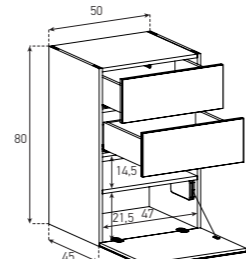

13083

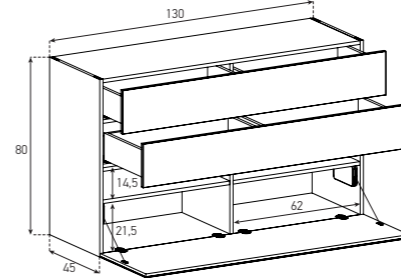

13084

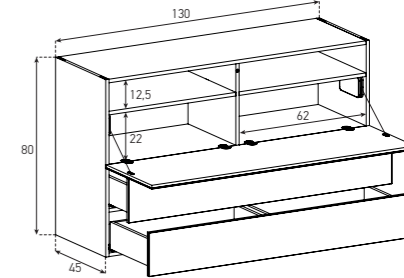

13084 T/P

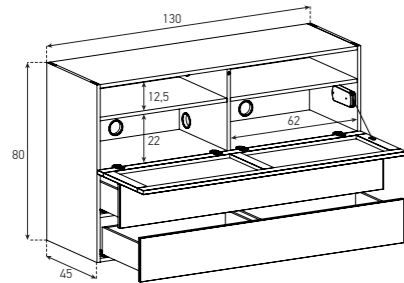

SIDEBOARD
CODE SAMPLE

SB-5061-WHT-BS-A(WHT)

1 2 3 4 5

BAR
100121

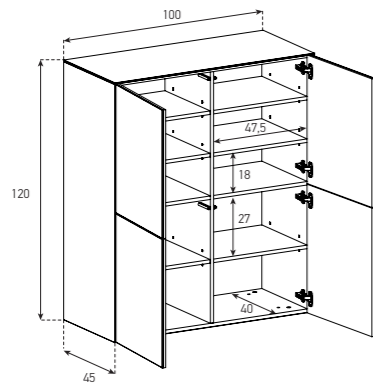

100122

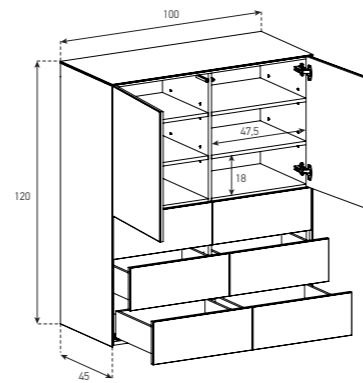

100123

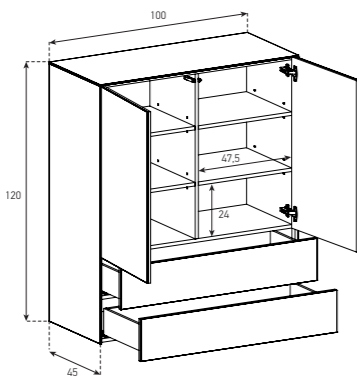

100124

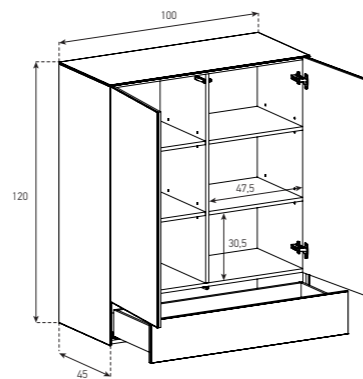

100125

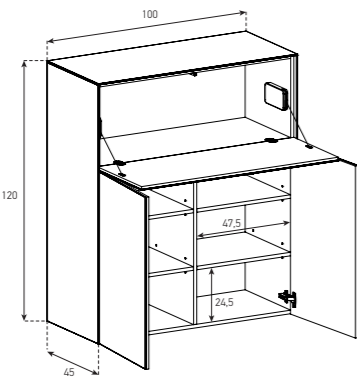

100126

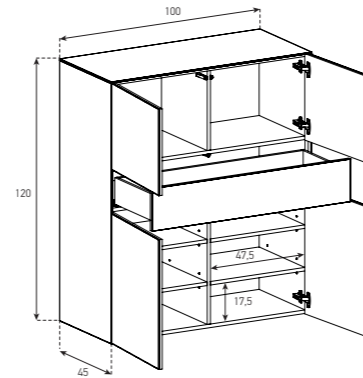

120121

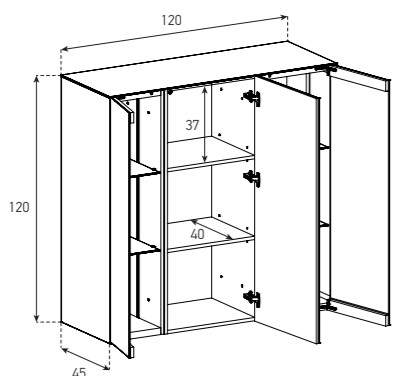

1) Cabinet Types : Page 101 - 108 (See technical drawings for more info)

	50cm	65cm	100cm	130cm
40cm	504#	654#	1004#	1304#
60cm	506#	656#	1006#	1306#
80cm	508#	658#	1008#	1308#
100cm	5010#	6510#	10010#	13010#



Total combination size
can not exceed 260cm

2) Door Colors & Decors : Page 76-71 "Category (A, A+, B, C, D, E & F) "

3) Base Options : Page 64-65 "Category (D) "

BS (3,5cm Base)	CG2 (20cm Metal Cage)	CRB (13cm Metal Crab)	S20 (20cm Metal Spike)	S13 (13cm Metal Spike)
WL (Wall Hanging)	CG4 (40cm Metal Cage)	TBE (13cm Metal Tube)	PLN (13cm Metal Plain)	



5) Side Glass Colors : Page 68-71 (D Type structure doesn't have side glass) "Category (A & A+) "

TOP GLASS CODE SAMPLE

SB-TG-WHT-195

TG = TOP GLASS GLASS COLOR SIZE* (CM)

METAL LEG CODE SAMPLE

SB-SPK-GRY-195

3 LEG COLOR

1. Total length of combination
2. Bars can not be a part of combination

COFFEE TABLES
CTR-120G

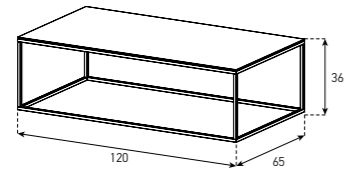

CTS-100G

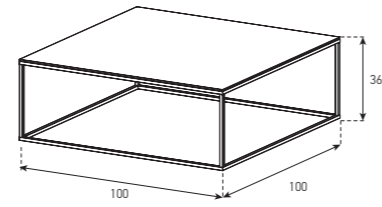

CT-SET 1

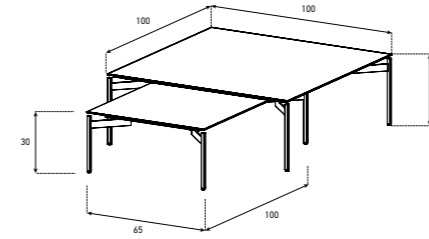

CT-SET2

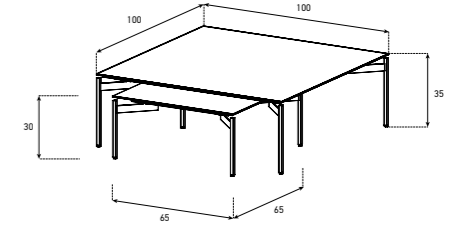

ES90D

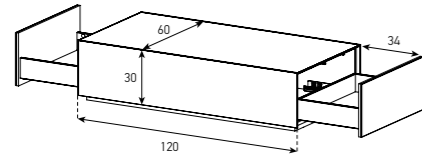

ES91D

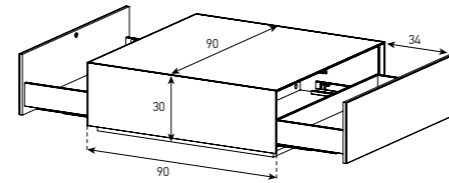

CT-SET1-A

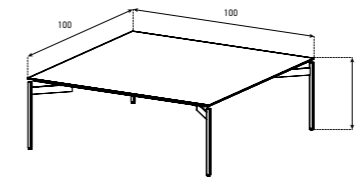

CT-SET1-BMR

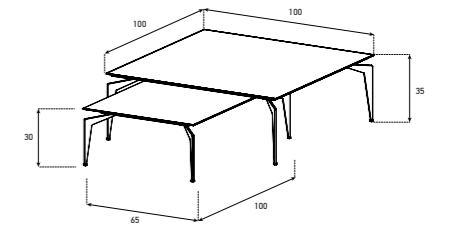

MAXI TRIPLE

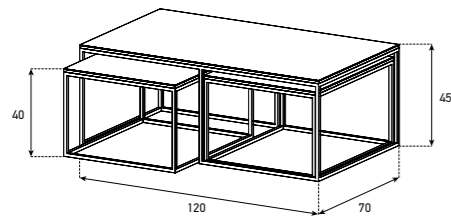

MAXI TRIPLE-A

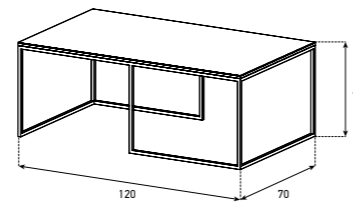

CT-SET2-BMR

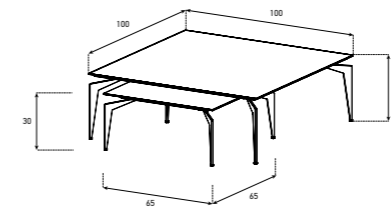

CT-SET1-BMR-A

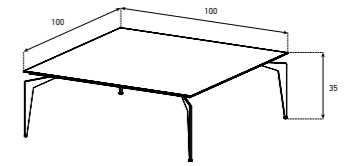

CT-SET 3

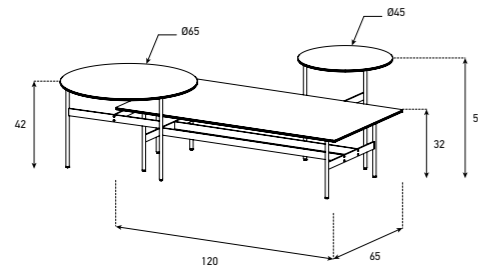

CT-SET3-A

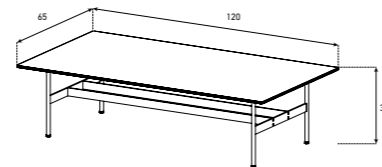

CTR-130C30

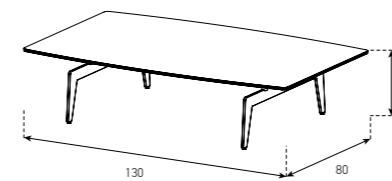

SABUL

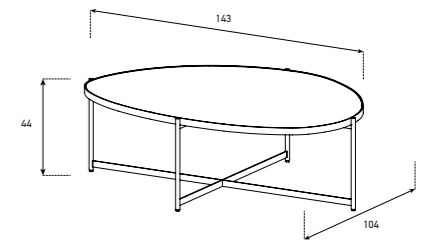

CT-SET4

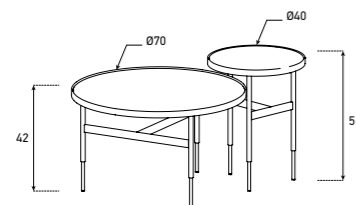

CT-SET4-A

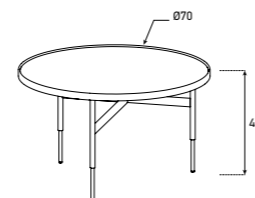

SIDE TABLES
MAXI TRIPLE-B

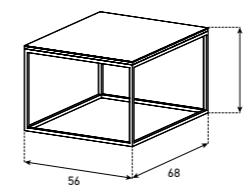

TRIPLE

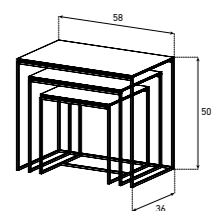

CT-SET2-B

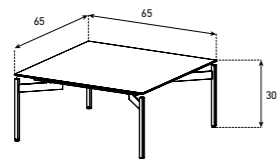

CT-SET1-B

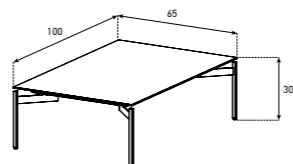

CT-SET2-BMR-B

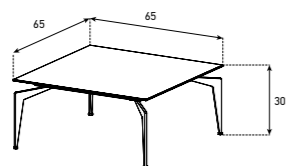

CT-SET1-BMR-B

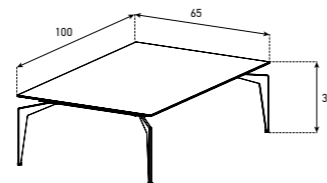

CT-SET3-B

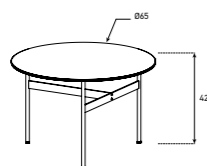

CT-SET3-C

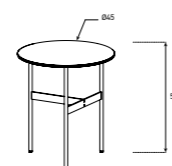

CT-SET4-B

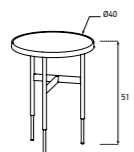

KL-42

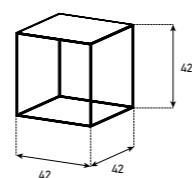

KL-49

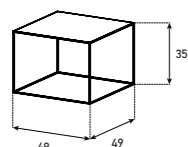

COFFEE TABLES AND SIDE TABLES
CODE SAMPLE

CTS-100G-WHT-GRY

1 2 3

1) Type :

2) Top Color & Decor : Page 68-71 "Category (A, A+ & F) "

3) Metal Leg Color : Page 68-71 "Category (D) "

Note : In case of set orders, encode different color and material preferences individually.

ES90D-WHT-WHT-CG2BLK

1 2 3 4 5

1) Cabinet Types

ES90D

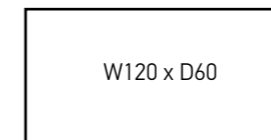

ES91D

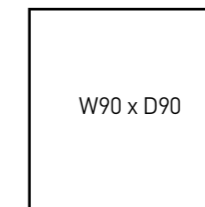

2) Cabinet Color & Decors : Page 68-71 "Category (A, A+ & B) "

3) Door Color & Decors : Page 68-71 "Category (A, A+, B, & F) "

4) Base Options :

2
(3,5cm Base)

CG2
(20cm Metal Cage)

5) Metal Leg Color : Page 68-71 "Category (D) "

DINING TABLES
TRAPEZOID

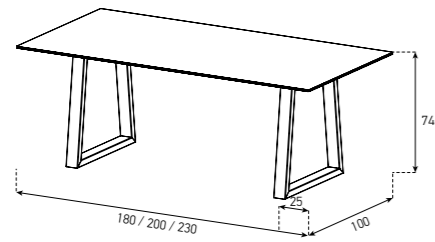

PORTAL

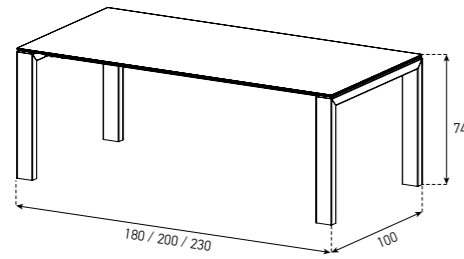

MIRROR

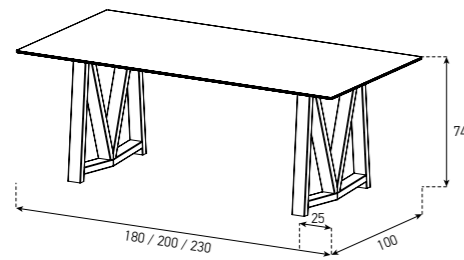

TWIN

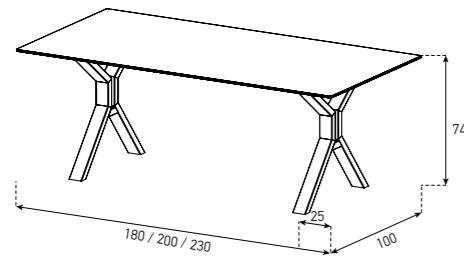

CONE

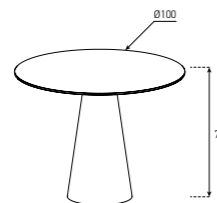

WARP

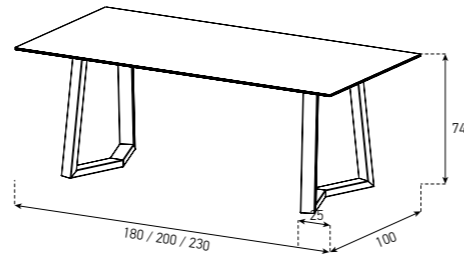

CHEVRON

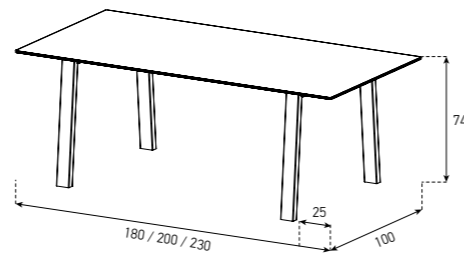

MAZE

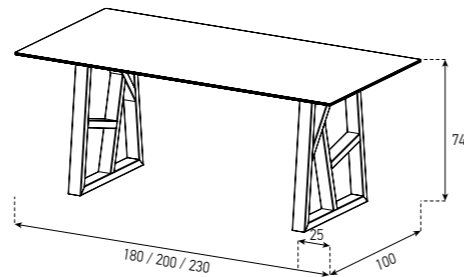

GONDOLA

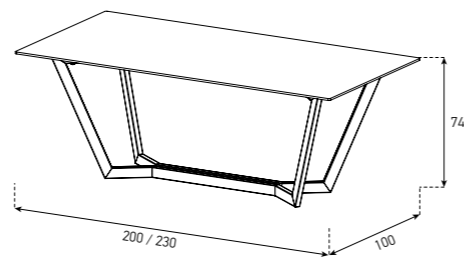

NET

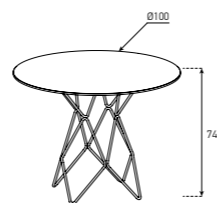

Table
CODE SAMPLE

TBL-F-R20EMP-MZ-BLK

1 2 3 4 5 6

1) Feature :

F
(Fixed)

L*
(Lift opening mechanism)

U*
(Universal opening mechanism)

2) Shape :

R
(Rectangle)

E
(Elliptical)

S
(Square)

C
(Circular)

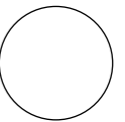
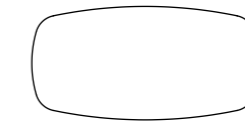
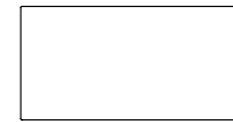

3) Dimensions (cm):

10
(100X100)

16
(160X100)

18
(180X100)

20
(200X100)

23
(230X100)

4) Table Decor :

5) Leg :

TR
(Trapezoid)

WR
(Warp)

TW
(Twin)

MZ
(Maze)

CH
(Chevron)

PT
(Portal)

MR
(Mirror)

GD
(Gondola)

CN
(Cone)

NT
(Net)

6) Leg Colors : Page 68-71 Metal legs "Category (D)"

Page 68-71 Solid wood leg only for PORTAL "Category (C)"

UNIVERSAL
OPENING

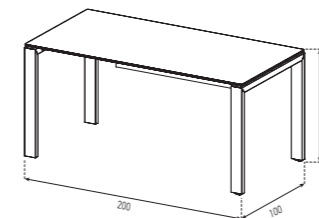

LIFT
OPENING

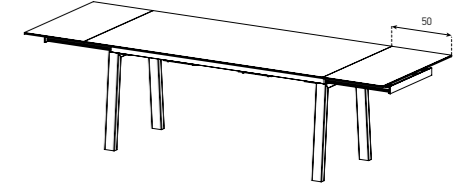
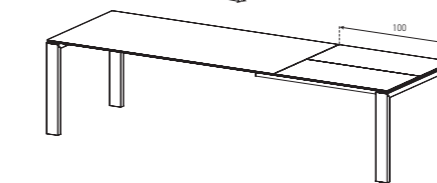
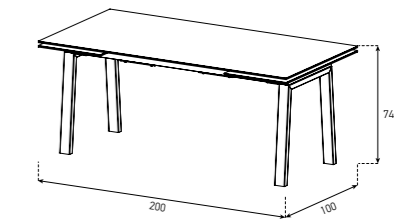

*Limitations:

- 1) Feature: Lift opening mechanism works only with "CHEVRON" leg. Universal opening mechanism works only with "PORTAL" leg.
- 2) Shape: Only "RECTANGLE" shape have opening mechanism
- 3) Dimensions: "16" is available for only "LIFT" feature
- 5) Legs: "CN" and "HX" only for "S" and "C" shaped tables

**SHELF & BOX SYSTEM
CODE SAMPLE**

SS-MDL-WHT-WHT

1 2 3

1) Shelf & box Module :

2) Metal Structure Color

3) Shelf Color : Wood laminate particleboard, Glass and Ceramic (Page 105 - 106)

SS-BOX-WHT-WHT

1 2 3

1) Box :

2) Body color

3) Door color : Wood laminate particleboard, Glass and Ceramic (Page 105 - 106)

SS-BOX

SS-MDL

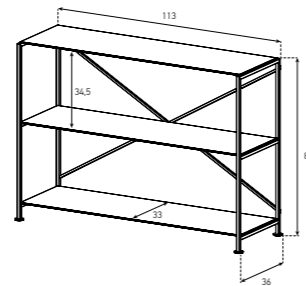
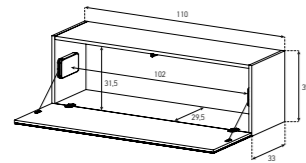

METAL STRUCTURE



BLK
BLACK



WHT
WHITE

GLASS COLORS *



BLK
BLACK



GRP
GRAPHITE



OLV
OLIVE



WHT
WHITE



SBA
SABBIA



GRA
GRIGIO ARGENTO



FYO
FJORD



BRD
BORDEAUX



RED
RED



BRW
BROWN



CPR
COPPER



RSP
ROSA PESCA



DBR
DARK BROWN



BGE
BEIGE



CPN
CAPPUCCINO



YLW
YELLOW



SFR
SAFFRON



PNA
PANNA



PIT
PISTACHIO



TRS
TERRA DI SIENA



BLU
DARK BLUE



BTN
BETON



VPL
VERDE PALLIDO



GRC
GRIGIO CHIARO



RVR
ROSSO VERMIGLIO

* For the acid etched (matte) glasses "C" must added to the end of the color code.
Example; "WHT" for regular gloss surface, "WHTC" for acid matte surface.

WOOD LAMINATE PARTICLEBOARD



CRY
CURRY



NGR
NIAGARA GREEN



SBLK
SOLID BLACK



AWHT
ALPINE WHITE

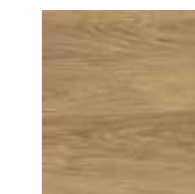

NCR
NATURAL CREAM



OAK
OAK

CERAMIC COLORS (Matte)



ANT
ANTHRACITE



EMP
EMPERADOR



TVR
TRAVERTINO



MPR
MOCHA PERLA



NDSM
NOIR DESIR



OXF
OXIDO-FLAME

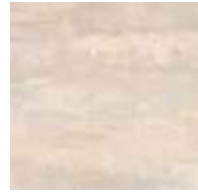

OXC
OXIDO-ICE



PLS
PALISSANDRO

CERAMIC COLORS (Shiny)



ALTS
ALTISSIMO



CAL
MICHELANGELO



NDS
NOIR DESIR

All information about the products in this catalog were correct at the time of going to press.
All colour reproductions serve as a guide only and are not reference patterns
Sizes that are listed in the catalogue are nominal sizes and no real measurements of production.
Differing measures and finishes are subjected to modification to a reasonable limit.
Changes that are due to improvement of quality and design do not require an advance notice.

